



Ideal solutions for industrial sliding gates



- Flexibility and safety thanks to a complete range engineered around different types of use - from industrial to intensive.
- Self-diagnosis of safety devices.
- A broad range of operators even with encoder-based movement control.
- Can control the auxiliary lighting in the passage area.
- PRATICO SYSTEM: for activating the radio release patented by CAME, you need to add a plug-in radio-frequency card.
- Module 4 or 6 pinions for transmitting fluid and linear movement to the rack.
- The BK-2200T model is three-phase powered to ensure greater thrust.

Dimensions (mm)

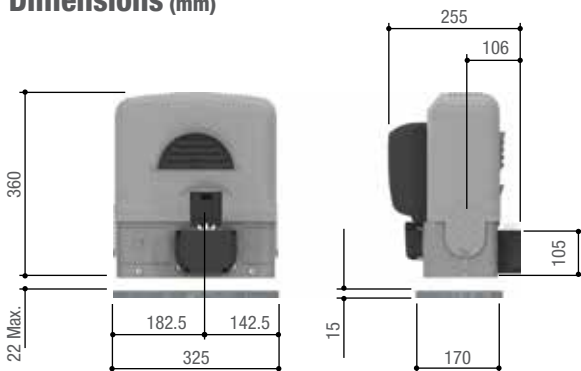

Limits to use

MODELS	BK-800	BK-1200	BK-1200P	BK-1800	BK-2200	BK-221	BK-2200T
Max leaf weight (kg)	800	1,200	1,200	1,800	2,200	2,200	2,200
Max leaf length (m)	20	20	14	20	20	20	23
Pinion module (m)	4	4	4	4	6	4	6
MODELS	BKE-1200		BKE-1800		BKE-2200		
Max leaf weight (kg)	1,200		1,800		2,200		
Max leaf length (m)	13		13		13		
Pinion module (m)	4		4		6		

NOTES: To activate the release device for 001BK-1200P, you need a plug-in radio frequency card of the same series used for the operator's radio command.







Technical features

MODELS	BK-800	BK-1200 • BKE-1200	BK-1200P	BK-1800 • BKE-1800	BK-2200 • BKE-2200	BK-221	BK-2200T
Protection rating (IP)	54	54	54	54	54	54	54
Power supply (V - 50/60 Hz)	230 AC	230 AC	230 AC	230 AC	230 AC	230 AC	230 - 400 V AC THREE-
Motor power supply (V)	230 AC 50/60 Hz	230 AC 50/60 Hz	230 AC 50/60 Hz	230 AC 50/60 Hz	230 AC 50/60 Hz	230 AC 50/60 Hz	230 - 400 V AC THREE-
Current draw (A)	4.5	3.3	3.3	4.2	5.1	5.1	1.5
Power (W)	520	380	380	480	580	580	600
Manoeuvre speed (m/min)	10.5	10.5	14.5	10.5	10.5	10.5	10.5
Duty cycle (%)	INTENSIVE SERVICE	50	30	50	50	INTENSIVE SERVICE	50
Thrust (N)	800	850	850	1,150	1,500	1,500	1,650
Operating temperature (°C)	-20 ÷ +55	-20 ÷ +55	-20 ÷ +55	-20 ÷ +55	-20 ÷ +55	-20 ÷ +55	-20 ÷ +55
Motor thermo-protection (°C)	150	150	150	150	150	150	150

● 230 - 400 V AC THREE-PHASE - ● 230 V AC

THE COMPLETE RANGE



Code	Description	Price £ (Excl. VAT)
Operators with 230 V AC gearmotor		
001 BK-800	Operator featuring control board and mechanical endstops, for sliding gates up to 800 kg and 20 m in length (INTENSIVE USE).	£779.00
001 BK-1200	Operator featuring control board and mechanical endstops, for sliding gates up to 1,200 kg and 20 m in length.	£590.00
001 BK-1200P 	Operator featuring control board, mechanical endstops and PRATICO SYSTEM radio release system, with on-board 12 V - 1.2 Ah battery, for sliding gates up to 1,200 kg and 14 m in length (requires additional frequency card).	£775.00
001 BK-1800	Operator featuring control board and mechanical endstops, for sliding gates up to 1,800 kg and 20 m in length.	£652.00
001 BK-2200	Operator featuring control board and mechanical endstops, for sliding gates up to 2,200 kg and 20 m in length.	£726.00
001 BK-221	Operator featuring control board with graphic display for function programming and movement control and obstacle detection device, for sliding gates up to 2,200 kg and 20 m in length.	£852.00
001 BKE-1200 	Operator featuring control board and encoder-based movement control, for sliding gates up to 1,200 kg and 13 m in length.	£701.00
001 BKE-1800 	Operator featuring control board and encoder-based movement control, for sliding gates up to 1,800 kg and 13 m in length.	£763.00
001 BKE-2200 	Operator featuring control board and encoder-based movement control, for sliding gates up to 2,200 kg and 13 m in length.	£837.00
230 – 400 V AC three-phase gearmotor		
001 BK-2200T 	Gearmotor for sliding gates up to 2,200 kg and 23 m in length.	£604.00
230 – 400 V AC three-phase control panel		
002 ZT6 	Control panel featuring self-diagnosis of safety devices.	£294.00
002 ZT6C 	Control panel with safety block and buttons, featuring self-diagnosis of safety devices.	£391.00
Accessories		
001 R001	Cylinder lock with DIN key.	£20.00
001 B4353	Device for chain transmission.	£213.00
009 CCT	1/2" simple chain.	per m £14.00
009 CGIU	Joint for 1/2" chain.	£3.00
Racks		
009 CGZ	Module 4 rack in galvanised steel (22 x 22 mm).	per m £20.00
009 CGZS	Module 4 rack in galvanised steel with holes and spacers for fixing (30 x 8 mm).	per m £22.00
009 CGZ6	Rack in galvanised laminated steel (30x30 mm).	per m £44.00



Price for complete Bk Kits (with control panels, activation and safety accessories included) can be found on page 68-69.