

INFRA-RED APARTMENT STATION

INTRODUCTION

The system has been designed primarily for elderly/disabled users. It enables the user to answer a call from a door panel either with a hand held remote control or from the wall station. Up to three apartment stations can be fitted into one apartment allowing the user to operate the system from the three most popular rooms (The remote control must be in line of site with the apartment station).

The infra-red apartment station is compatible with almost all Videx systems.

The apartment station has the following features :-

- ¾ 12V DC operation.
- ¾ Speak Button.
- ¾ Door open button.
- ¾ Dry contact timed door opening. (Two optional times).
- ¾ Electronic call tone.
- ¾ Call tone volume adjust. (Two options available by altering the position of jumper J5 in the apartment station).
- ¾ Dry contact alarm relay.
- ¾ Timed privacy button and red indicator LED. (Four optional times).
- ¾ Extension speaker output.
- ¾ IR signal received green indicator LED.
- ¾ Independently adjustable volume for both transmit and receive.
- ¾ Busy signal to avoid more than one apartment station talking at once.

The remote control has the following features :-

- ¾ Two versions available. (Too sensitive or large buttons)
- ¾ Powered from an inexpensive PP3 9 volt battery.
- ¾ Speak Button.
- ¾ Open Button (Also used to switch on privacy when there are no calls on the system).
- ¾ Send an alarm signal (Press both the Talk and Open at the same time for 3 seconds).
- ¾ Red LED to indicate buttons pressed.
- ¾ Built in delay (To avoid accidental pressing of buttons).

Operation

Receiving a call :When a call is made from the door station, the apartment station will begin to ring. The call can be answered one of two ways: either by pressing and holding the TALK button on the wall station, or by holding the same button on the remote control. Holding the TALK button allows the occupant to talk to the caller, releasing the button allows the occupant to listen to the caller. Pressing the OPEN button on either the apartment station or the remote control opens the door and ends the call (Ending a call without opening the door is accomplished by pressing nothing for 30 seconds at which time the call will end. When pressing the talk or open buttons a small delay will take place before the system will acknowledge the button being pressed (When the system accepts the button press, the apartment station will beep). This delay is incorporated into the software to avoid accidental pressing of buttons.

Door open time :-

J3	TIME
OFF	2 SECONDS
ON	5 SECONDS

Switching the privacy on The privacy can be switched on in one of two ways: either by pressing the privacy switch on the wall station or by pressing the OPEN button on the remote control (only possible when the system is not busy). The privacy can be switched off by pressing the button again allowing the preset time to end.

Privacy time :-

J1	J2	TIME
OFF	OFF	30 MINUTES
OFF	ON	1 HOUR
ON	OFF	2 HOURS
ON	ON	8 HOURS

Switch the alarm relay on The alarm relay can be activated by keeping both buttons on the remote control pressed. When triggered, the dry contact alarm relay will activate.

Installation

When deciding the position of the wall mounted apartment station it is very important that the station is not mounted in direct sight (This is because the IR receiver like all similar units is sensitive to sunlight and may effect the performance).

Important note: When using the 500MM apartment station with the Art2280 interface, links must be fitted across the traces next to J6 to put them in short as shown in the diagram below :-

Fit links

Lock release back EMF protection A capacitor must be fitted across the terminals on an AC lock release and a diode must be fitted across the terminals on a DC lock release to suppress back EMF voltages. The diagrams below show how to connect these components to the lock releases



Cable size and type When running cables for any intercom system, these cables

must be installed separately from the mains cables. All multi pair cables should be to CW1308 specification. (0.5mm twisted pair telephone cable) Max resistance = 10 Ohm.

Lock release wires should be double. Max resistance = 3 Ohm

The cables sizes above can be used for distances up to 100m. On distances above 100m the cable sizes should be increased to keep the overall resistance of the cable below the RESISTANCES indicated above.

After completing the wiring (following the supplied wiring diagram), adjust the link options within the apartment station to the desired setting and power up the system. (If the apartment station is connected to the VX2000 system then set jumper J6 to position A. All other systems set jumper J6 to position B.

Finally, adjust the volume levels using the volume controls found in the apartment station (taking into consideration that the user may be using the remote control some distance from the wall unit).

Specification :-

	Apartment Station	Remote Control
Working Voltage	12V DC	9VDC PP3 Battery
Current (Quiescent)	10mA	70uA
Current (During operation)	200mA max.	30mA max.
Alarm Relay contacts	0.5A @ 110V AC 1A @ 24V DC	
Lock relay contacts	0.5A @ 110V AC 1A @ 24V DC	

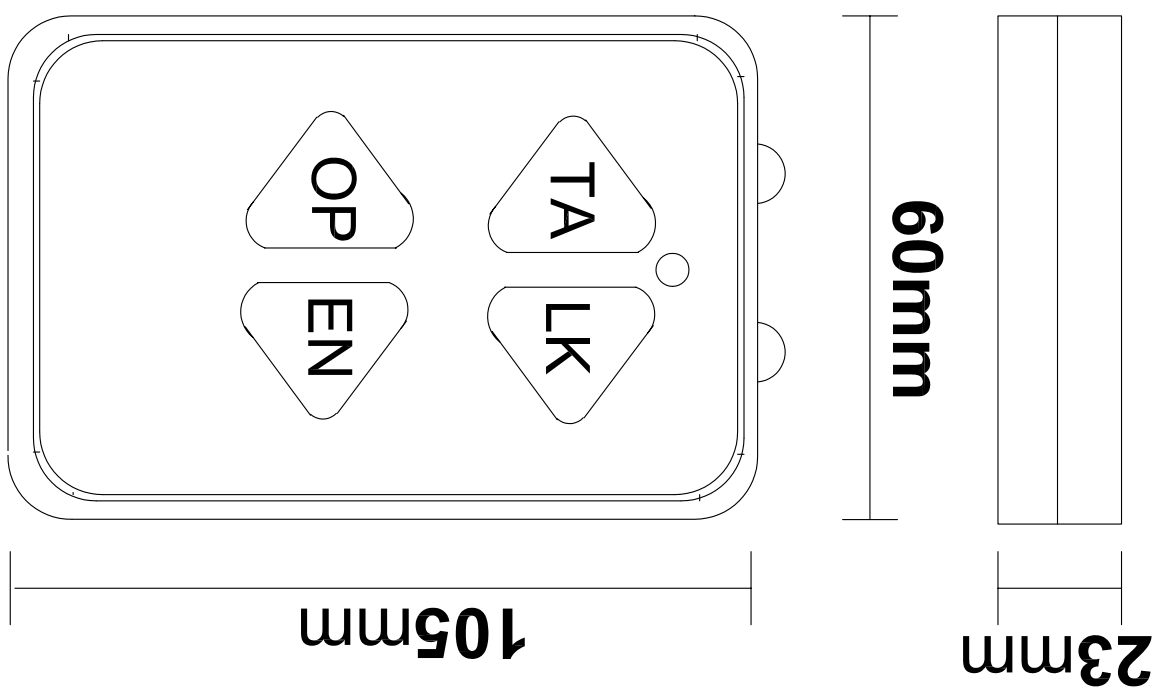
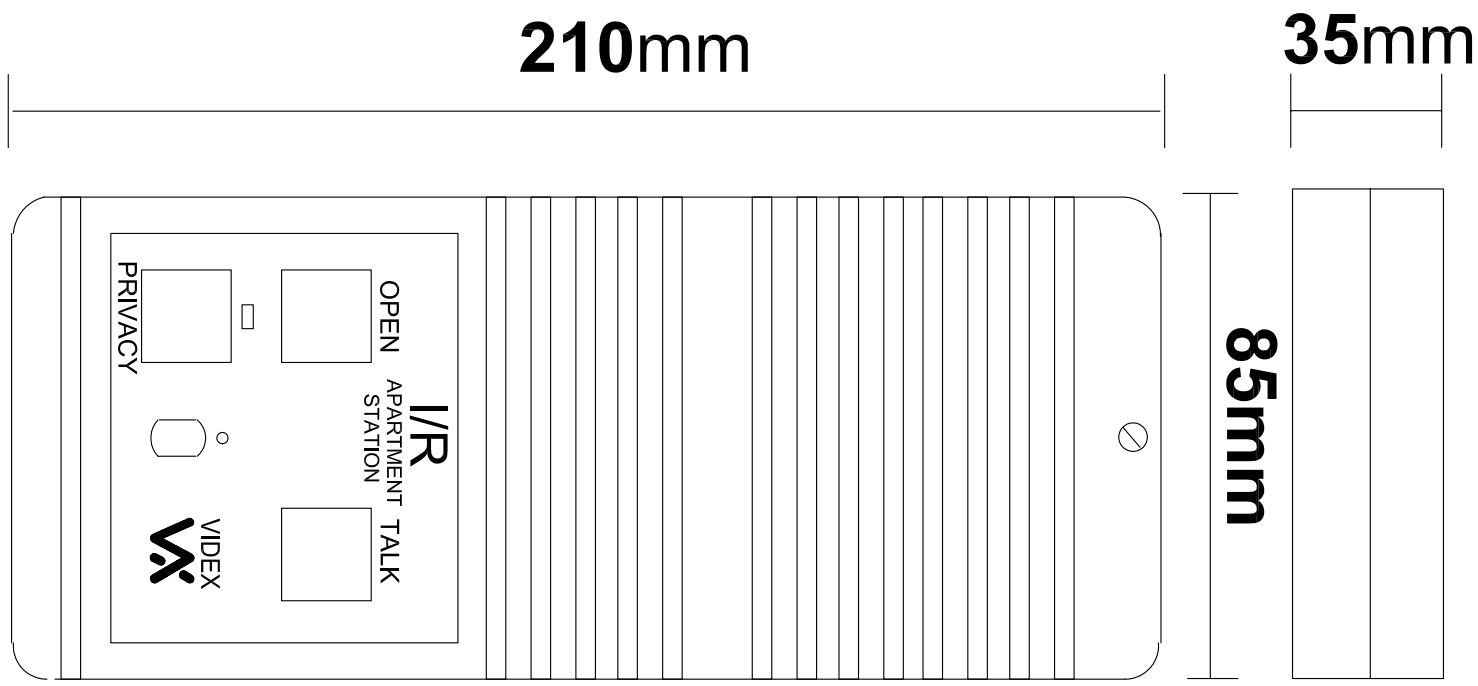
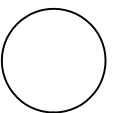

500MM

IR911

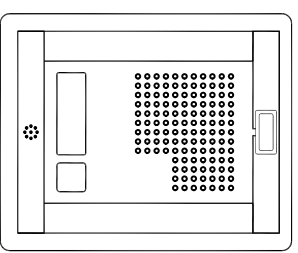
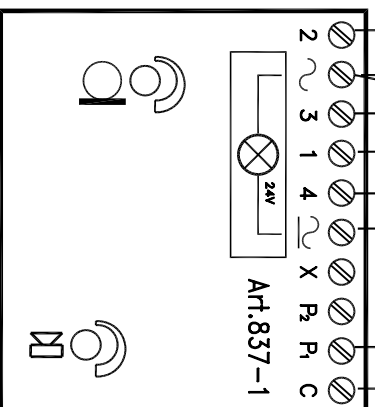
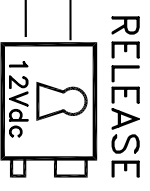
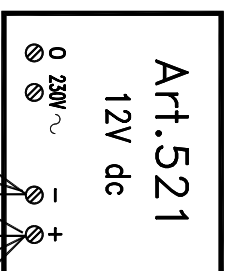
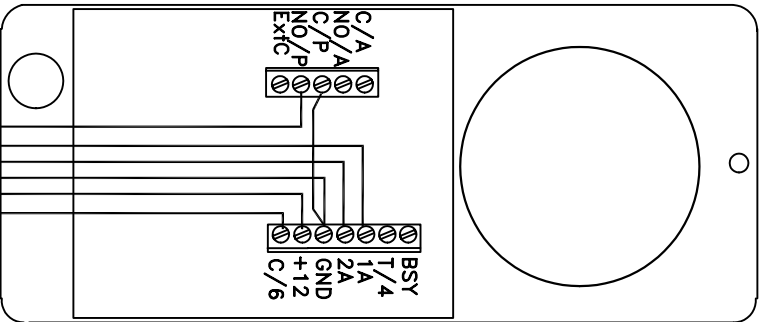
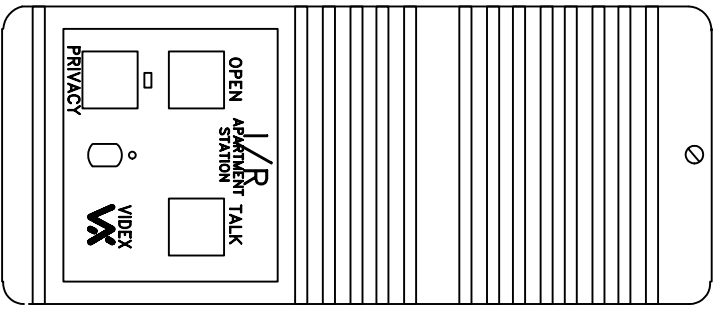

VIDEX SECURITY (UK) LTD
Technical Line 0191-224-3174

IR911 + Additional apartment station

500MM

500MM

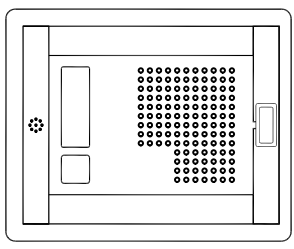
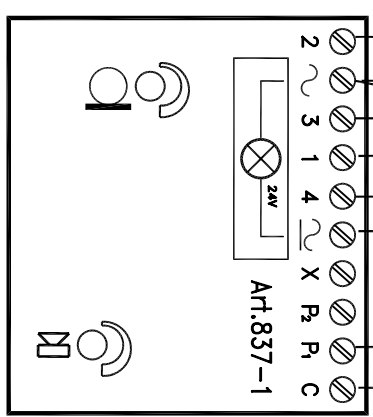
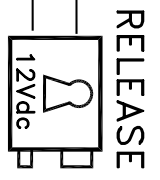
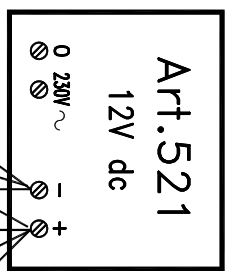
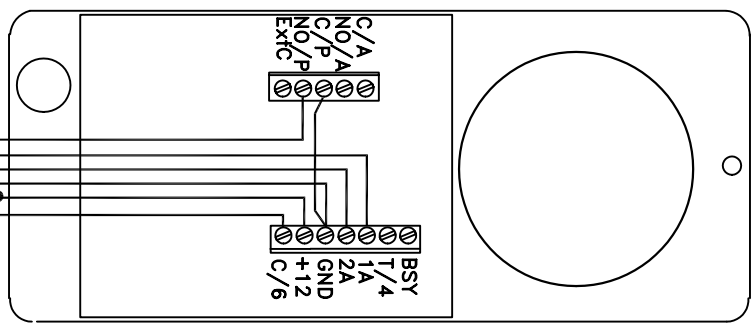
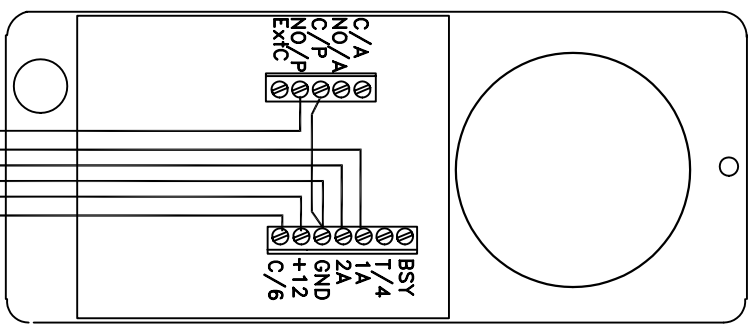
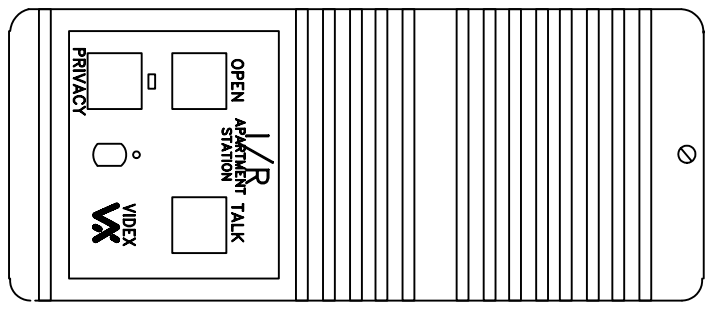

VIDEX SECURITY (UK) LTD
 Technical Line 0191-224-3174

EK911 / IR + 924

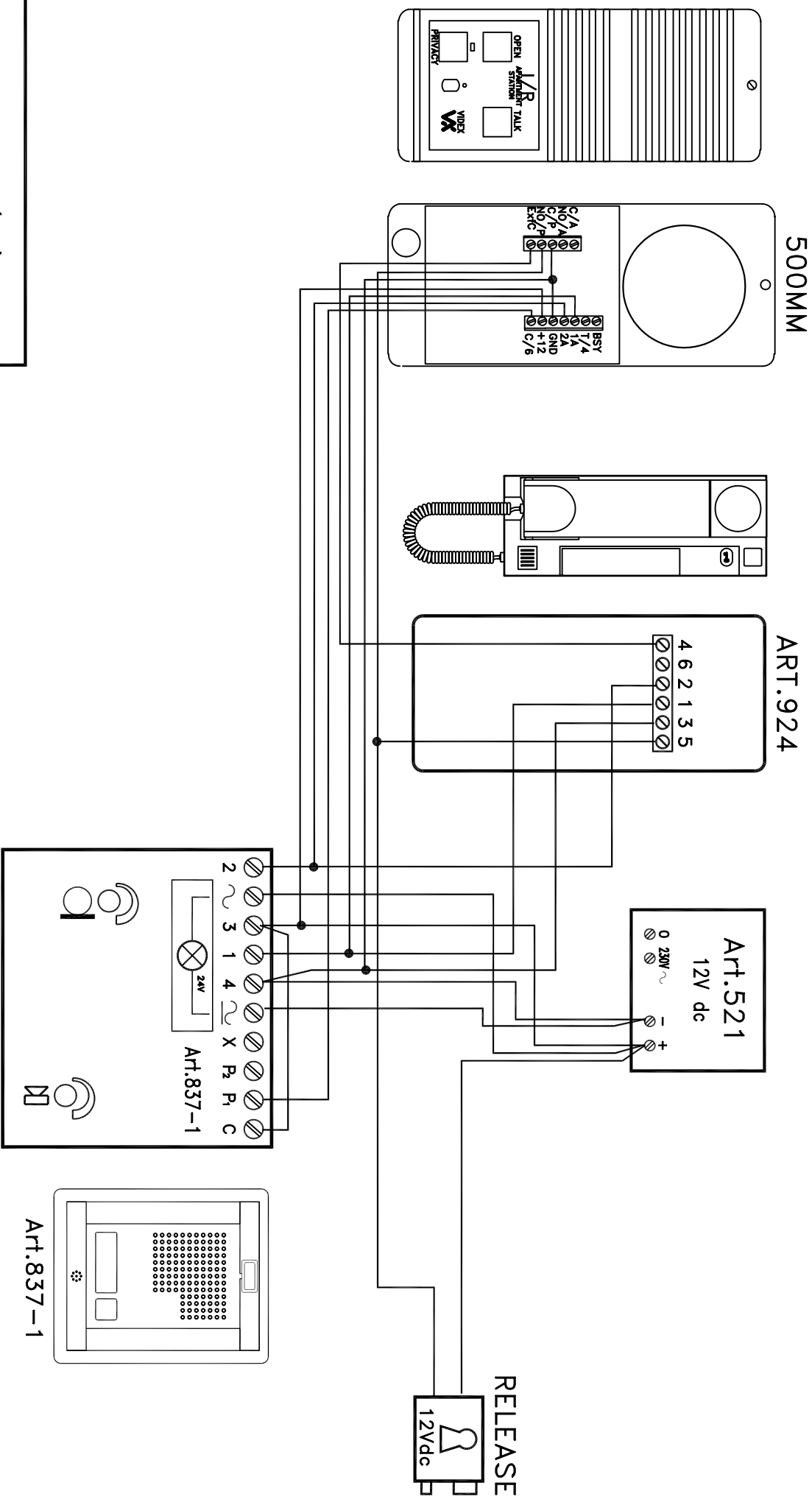

VIDEX SECURITY (UK) LTD
 Technical Line 0191-224-3174

VR1 / IR + Additional apartment station

500MM

500MM

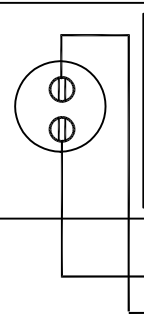
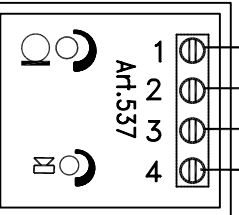
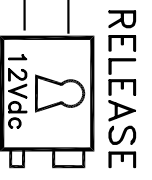
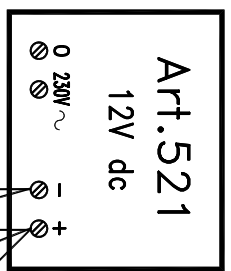
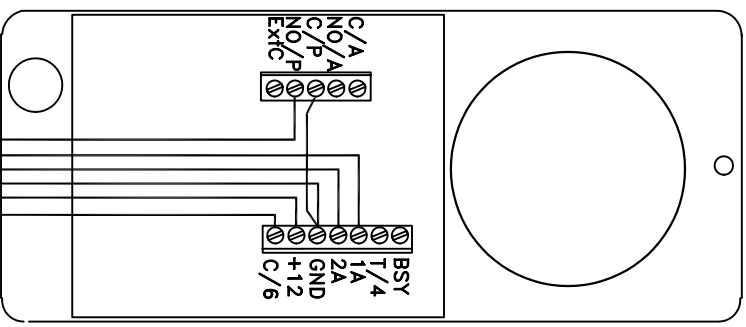
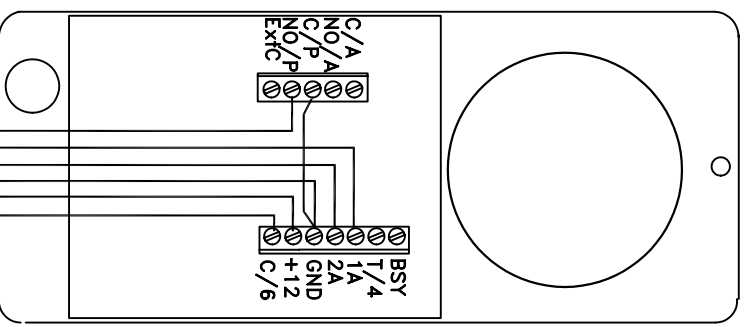
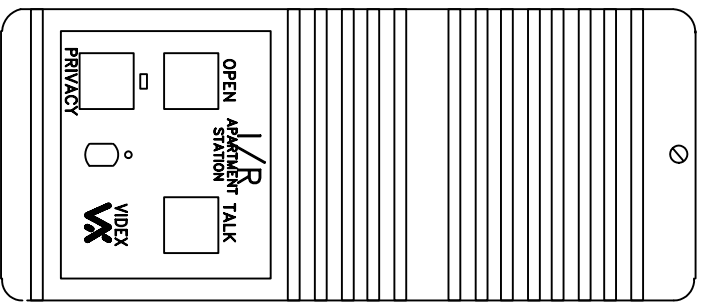

VIDEX SECURITY (UK) LTD
 Technical Line 0191-224-3174

500MM

ADDITIONAL SPEAKER

IR911

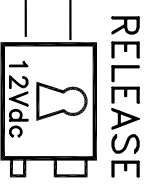
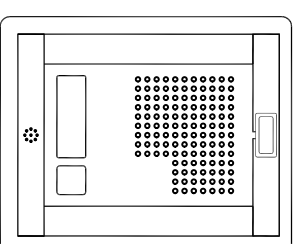
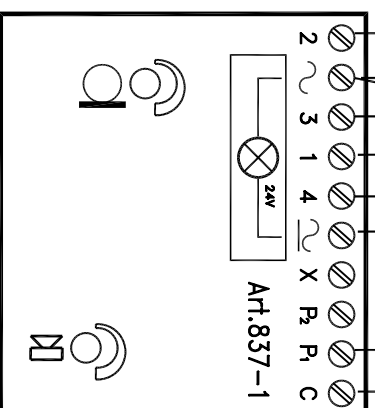
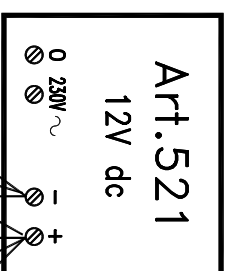
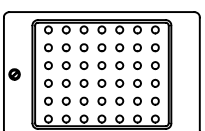
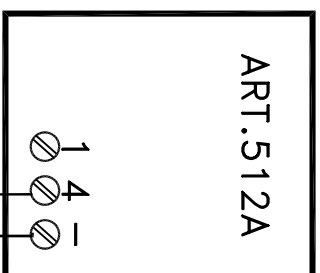
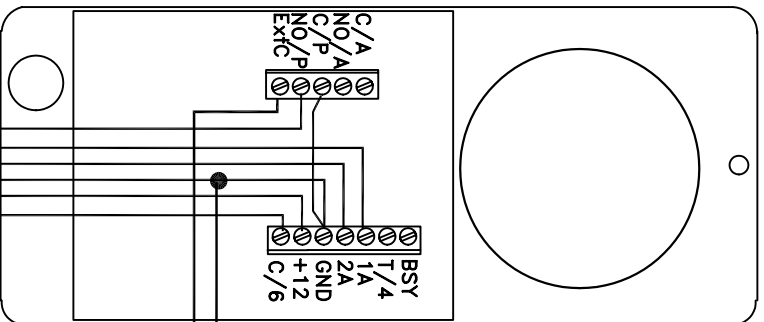
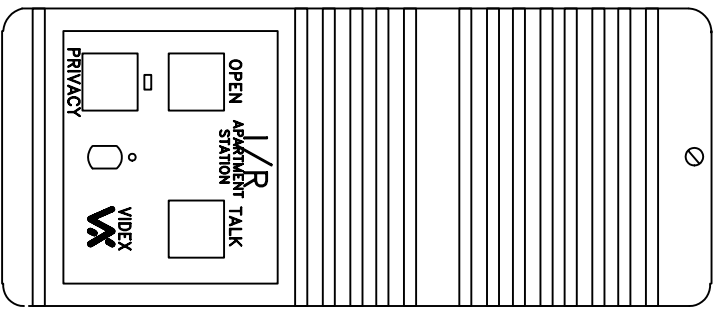

VIDEX SECURITY (UK) LTD
Technical Line 0191-224-3174

IR911 + 2 Additional apartment station

500MM

500MM

500MM

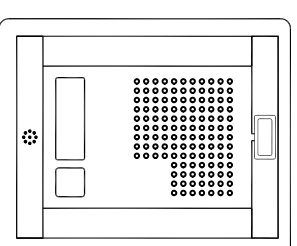
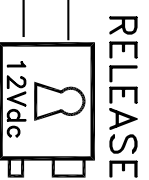
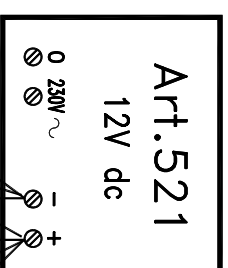
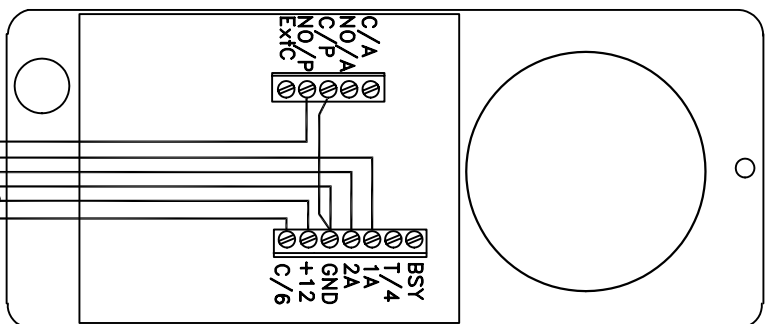
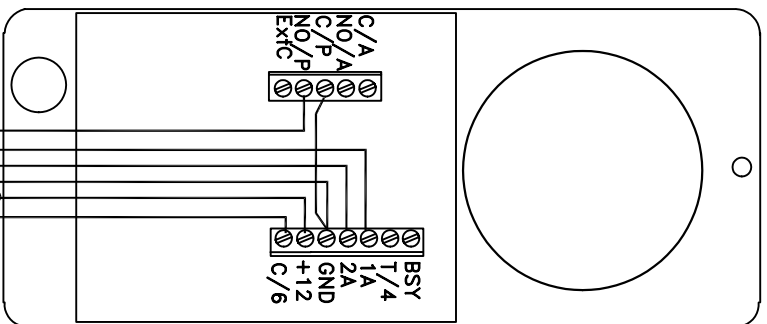
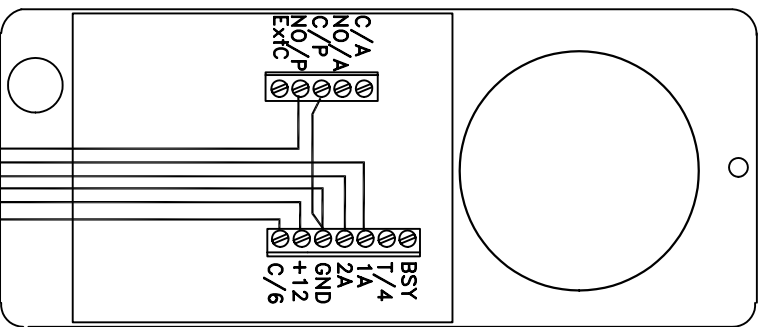

500MM

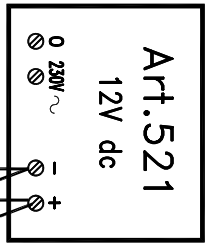
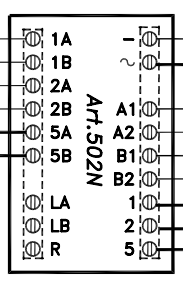
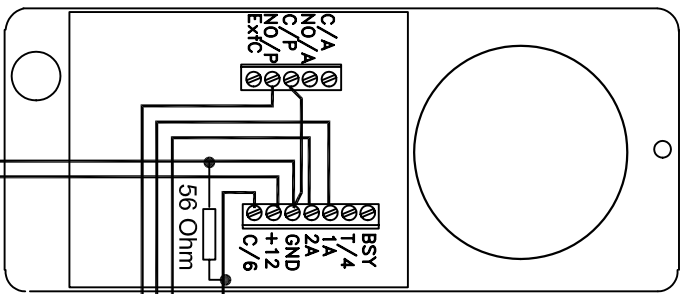

RELEASE



RELEASE

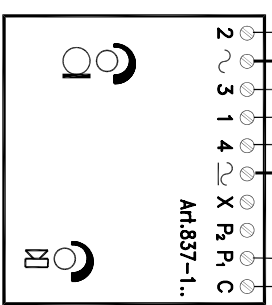

A

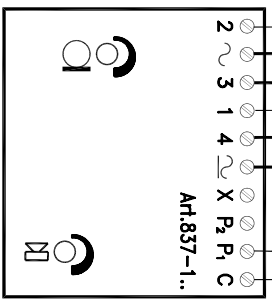

B

85905171

VIDEX

USER

INSTRUCTIONS



IR Apartment
station kit

ANSWERING A CALL USING THE APARTMENT STATION

WHEN A CALL IS PLACED TO YOUR APARTMENT, AN AUDIBLE TONE WILL BE HEARD FROM THE STATION.

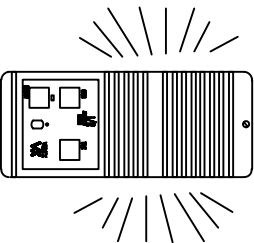

TO ANSWER THE CALL, PRESS THE TALK BUTTON.

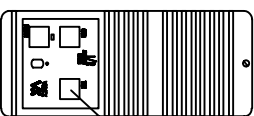

TO TALK, PRESS AND HOLD THE TALK BUTTON. TO LISTEN, RELEASE THE TALK BUTTON

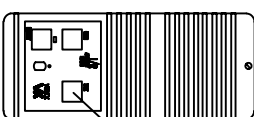

TO OPEN THE DOOR SIMPLY PRESS THE LOCK BUTTON. ALTERNATIVELY TO END THE CALL SIMPLY DON'T PRESS ANY BUTTONS FOR 30 SECONDS.

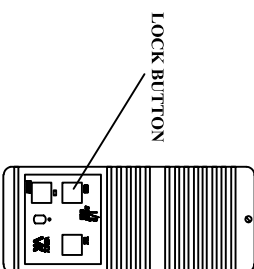

ANSWERING A CALL USING THE REMOTE CONTROL

WHEN A CALL IS PLACED TO YOUR APARTMENT, AN AUDIBLE TONE WILL BE HEARD FROM THE STATION.

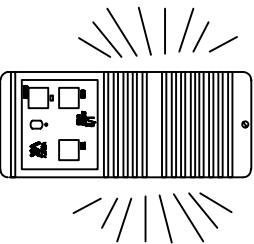

TO ANSWER THE CALL, POINT THE REMOTE AT THE WALL STATION AND TOUCH THE TALK PADS.

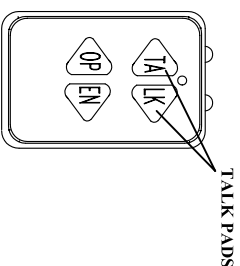

TO TALK, KEEP TOUCHING THE TALK PADS. TO LISTEN RELEASE THE TALK PADS.

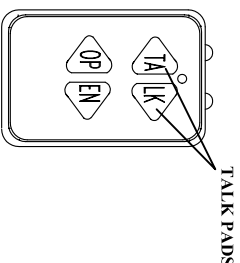

TO OPEN THE DOOR SIMPLY TOUCH THE OPEN PADS. IF THE DOOR IS NOT TO BE OPENED, SIMPLY DON'T TOUCH ANY PADS FOR 30 SECONDS AND THE CALL WILL END.

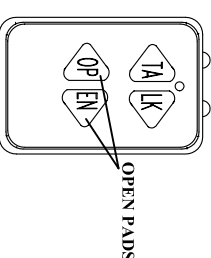

PRIVACY MODE

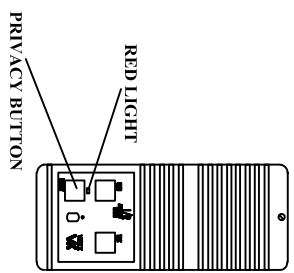

TO PUT THE APARTMENT STATION INTO A DO NOT DISTURB MODE SIMPLY PRESS THE PRIVACY BUTTON ON THE APARTMENT STATION OR TOUCH THE OPEN PADS FOR 5 SECONDS ON THE REMOTE CONTROL. A RED LIGHT ON THE APARTMENT STATION WILL INDICATE THE PRIVACY MODE IS ON. TO SWITCH OFF, SIMPLY PRESS THE BUTTON AGAIN.

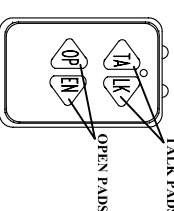
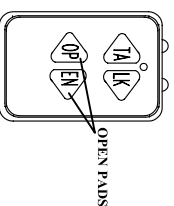

ALARM RELAY

TOUCHING BOTH THE TALK PADS AND THE OPEN PADS TOGETHER FOR 5 SECONDS WILL ACTIVATE THE ALARM RELAY.

