

# First of all, power up the handsets and controllers!

## 1. Power the handsets:

- mains recharged handsets are supplied with 3 NiCad batteries already fitted
- battery recharged handsets are supplied with a lithium battery fitted but not connected.



## 2. Power the handsets charger units:

- battery base: fit the 4 alkaline LR20 batteries



- mains base: connect the power adaptor to the mains



## 3. Put the handsets on charge on their respective bases

Don't swap handsets between bases, as a mains recharged handset must not be used on a battery base and vice versa (check the label on the back of each handset).



## 4. Power the pilot controller and the radio controllers (ref. Connections, p. 100/101).

## 5. Connect the battery of each controller (ref. Description of the controllers, p. 96)

*After about 1 hour, the battery systems of the handsets and controllers are partially charged.*

*This minimum charge time is sufficient for needs of the installation (to carry out programming and function checks).*

*After 24 hours, the battery systems of the handsets and controllers are completely charged. This charge time is necessary for the correct working of the system once the installation is finished.*

# Contents

<b>Principle of operation</b>	<b>p. 92-94</b>
<b>Installation Precautions</b>	<b>p. 95</b>
<b>Description of the controllers</b>	<b>p. 96</b>
<b>Installing the caller units</b>	<b>p. 97</b>
<b>Installation</b>	<b>p. 98-99</b>
<b>Connections</b>	<b>p. 100-103</b>
<b>Programming</b>	<b>p. 104-107</b>
<b>Functional test</b>	<b>p. 108</b>
<b>What to do if...?</b>	<b>p. 109-110</b>
<b>Technical characteristics</b>	<b>p. 111</b>

*Depending upon the country and distribution network, certain products or certain functions may not be available.*

*For the installation of handsets intended for use with the DoorPhone for Multi-apartments, please refer to the User Guide provided with the handset(s).*

Symbol:  risk of electric shock



# Principle of operation

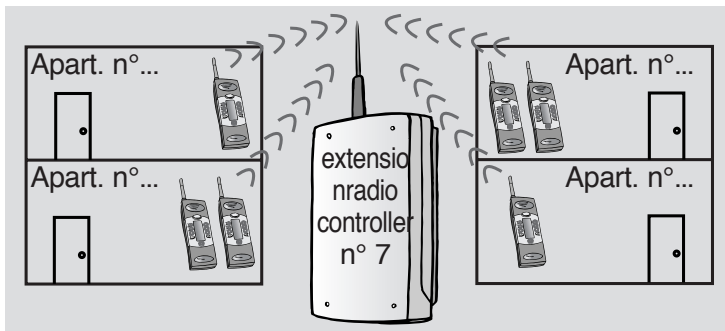

Example of grouping of handsets assigned to the radio controller n° 7



**Cable gauges required:**

- pilot controller links  
→ base radio controller:
  - Ø 6/10 up to 100m
  - Ø 9/10 up to 200m
- base radio controller link  
→ extension radio controller:
  - Ø 6/10 up to 200m
  - Ø 9/10 up to 300m

up to 6 extension radio controllers

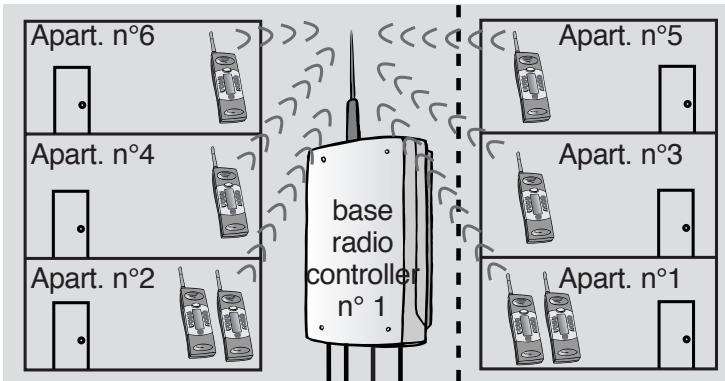

Example of grouping of assigned handsets to the base radio controller

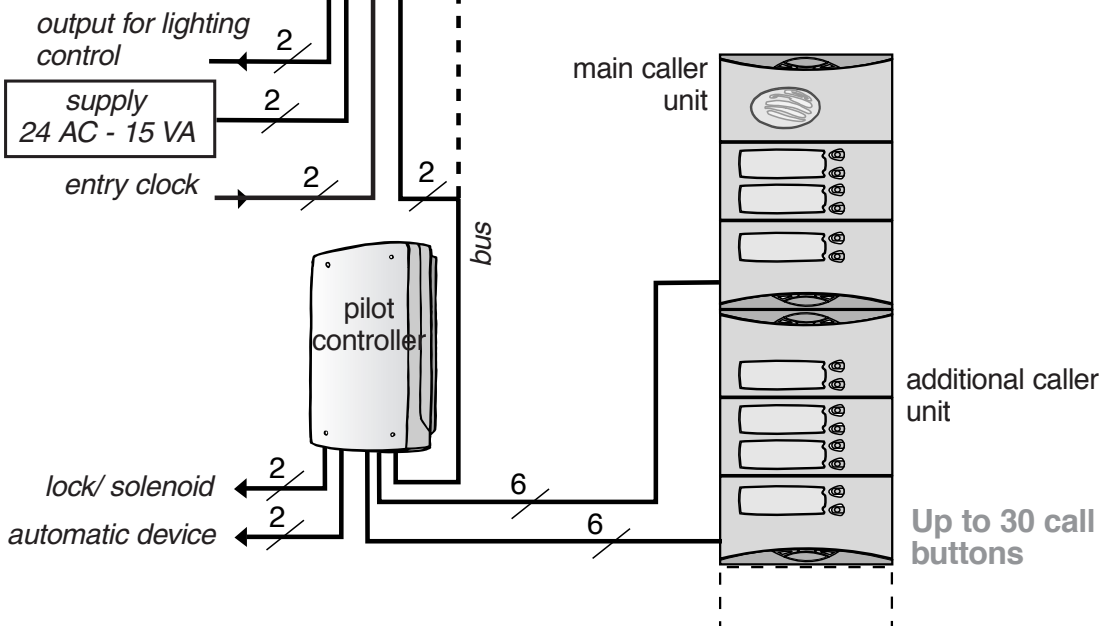

# Principle of operation

## ➤ **Principle**

The multi-dwelling DoorPhone is comprised as a minimum of pilot controllers + base radio controller, one or several caller units according to the number of apartments to equip (1 call button per apartment) and several handsets (this number is at least equal to the number of apartments but is unlimited).

The base radio controller sends the radio transmission to the apartments.

To do this, all related handsets must be assigned to the base radio controller. All of these handsets constitute a group assigned to the same radio controller, in this case the single base radio controller is sufficient to cover all of the apartments.

Radio range tests of the site will determine whether the addition of an extension radio controller may be necessary.

The radio controllers (6 is the maximum) allow you to get radio coverage throughout the site (1).

Unless used for other installation reasons, each radio controller will be associated with some number of handsets.

**In conclusion, on an installation there is at the minimum:**

<b>X</b> handsets communicating with the base radio controller	➔	grouping of handsets assigned to the base radio controller
--	---	--

**In addition, it will be necessary to add (depending upon the building):**

<b>X</b> handsets communicating with extension radio controller n° 2	➔	grouping of handsets assigned to the base radio controller n° 2
-----		
<b>X</b> handsets communicating with extension radio controller n° 7	➔	grouping of handsets assigned to the base radio controller n° 7

**ATTENTION: every handset cannot be assigned to only one radio controller!**

(1) The quality of radio coverage and therefore the performance of the DoorPhone can be affected by obstacles situated between the radio controller and the handset: walls, partitions, tiles, lift-shaft comprising metallic elements etc.  
(Also, the radio coverage can be affected by electric or electromagnetic interference.)



# Principle of operation

## ➤ **Power supply and connection**

- The base radio controller is powered by 24 VAC via the 230 V / 24 V transformer supplied. The whole of the installation (pilot controller and extension radio controller) is powered via one bus (2 wires).
- Caller units connect to the pilot controller. This controller accepts up to 4 caller units: 1 main caller unit (equipped with the loudspeaker and microphone) and up to 3 additional caller units.
- The pilot controller connects to the base radio controller. The extension radio controllers (6 max.) can be connected to the base radio controller.
- Other possible connections:
  - electric door releases,
  - automatic device,
  - courtesy lighting,
  - programming clock,
  - Vigik® unit.

## ➤ **The possible commands**

- The control of an electric lock or solenoid from:
  - each handset,
  - the main caller unit and keypad with the input of an access code (1),
  - a pushbutton "egress" switch situated inside the entrance hall.
- The control of an automatic device (garage door, gate...) from:
  - each handset,
  - the main caller unit and keypad with the input on an access code (1),
- The control of lighting (entrance hall, stairwells...) from:
  - each handset,
  - automatically (if switch n° 4 in the pilot controllers is positioned to ON):
    - on every opening of door or gate if position contacts are connected to the pilot controllers,
    - on every command of the electric door lock.

(1) *The use of the caller unit with keypad without the need for the access code, can be achieved in two ways:*

- 1. an entrance clock can be connected to the base radio controller.*
- 2. the programming of the authorisation code for the entrance clock can be programmed from the caller unit with keypad (see. Programming chapter).*

# Installation precautions

**ATTENTION:** Before any work, remove power from the system!

The installation must be carried out respecting all national and local requirements. All work must be done by trained and qualified personnel. The supplied transformer must be protected by a fuse (fuse or thermal cutout) and by a 30mA differential cutout!

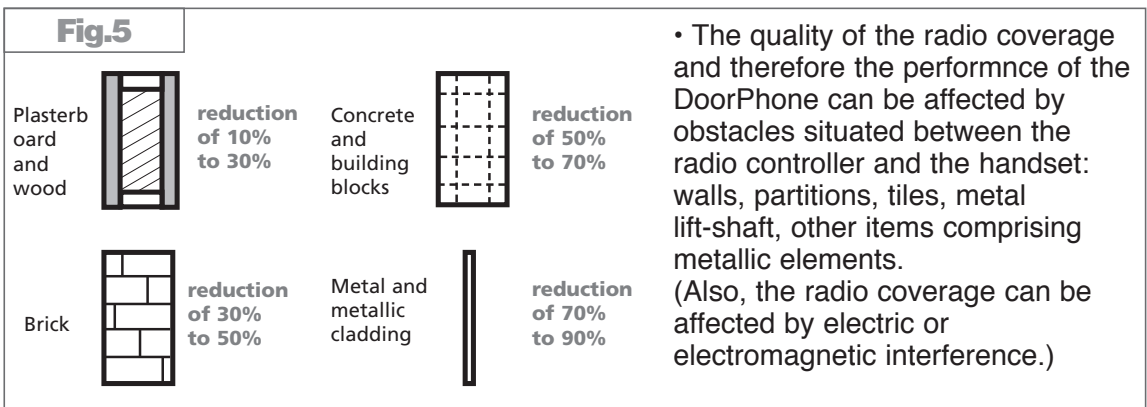
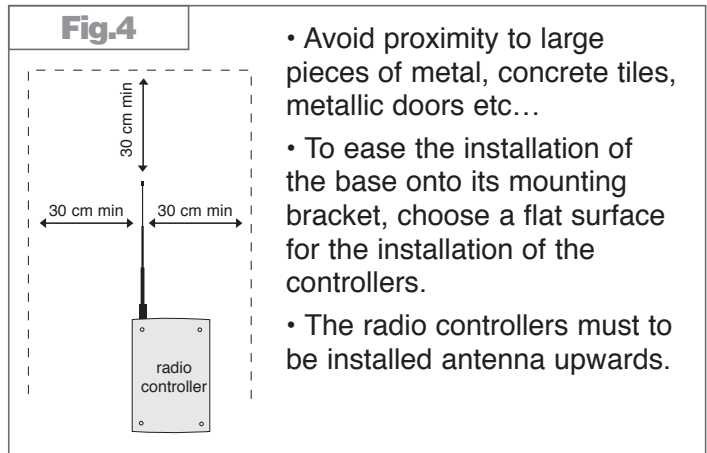
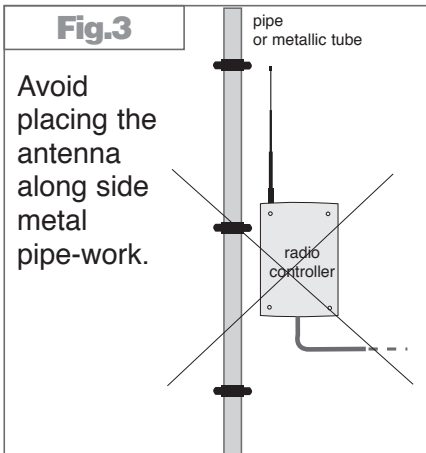
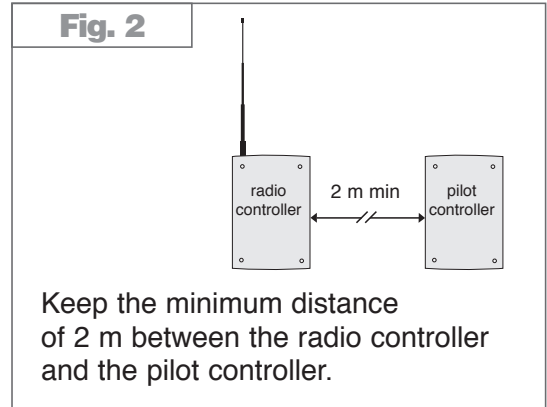
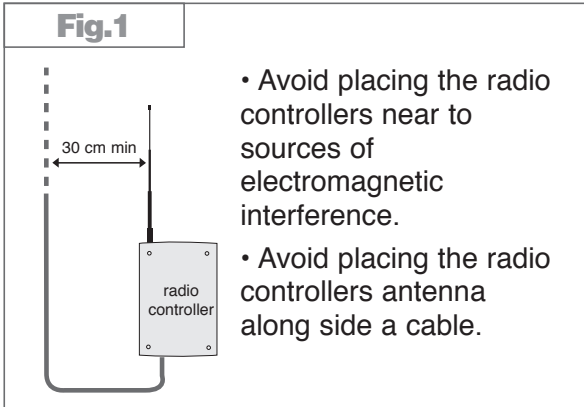

# Description of the controllers

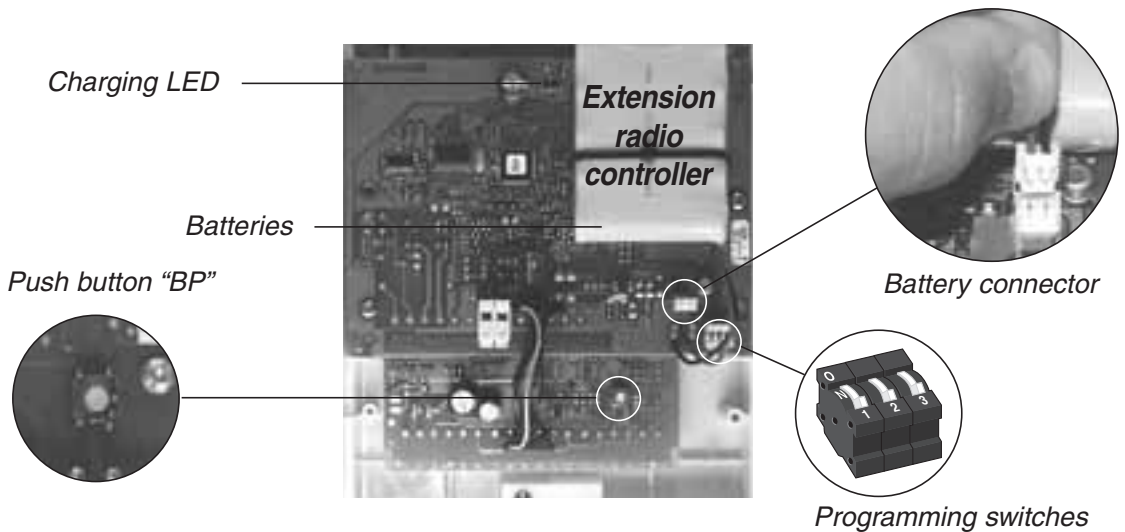
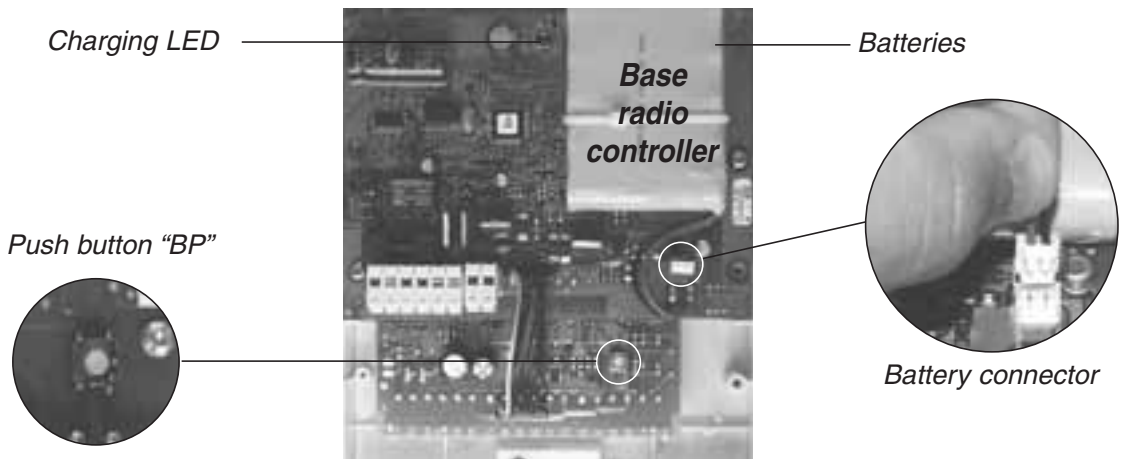
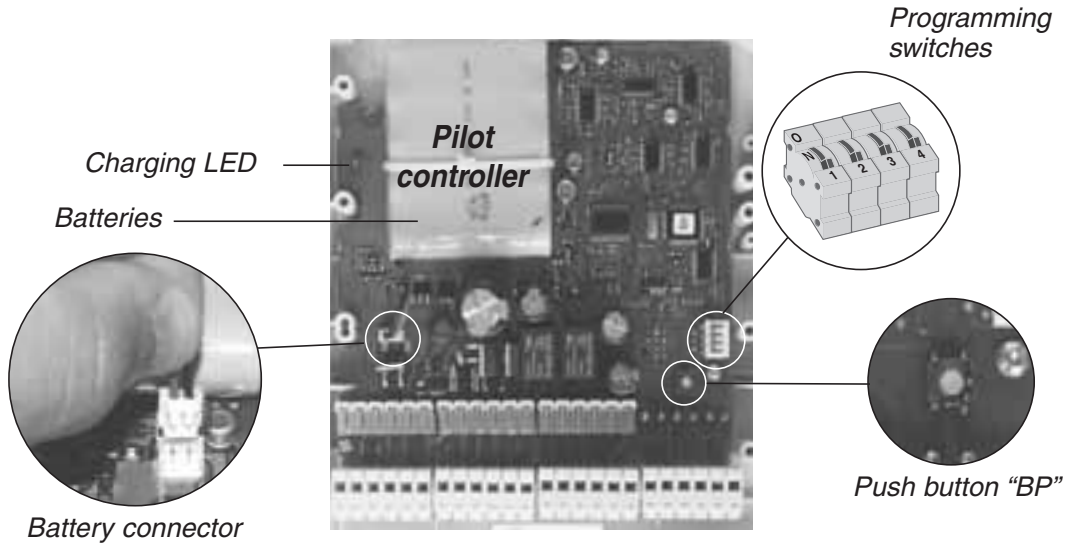

# Installing the caller unit(s)

**ATTENTION:** For the installation of caller units and their metal covers, refer to the assembly instructions provided with the installation kit of the metal cover modules.

Ref. step ⑤

Using the panel of name label provided, note the name of the resident corresponding to each call button and download your printing software at <http://www.logisty.co.uk/doorphones/install/index.htm>

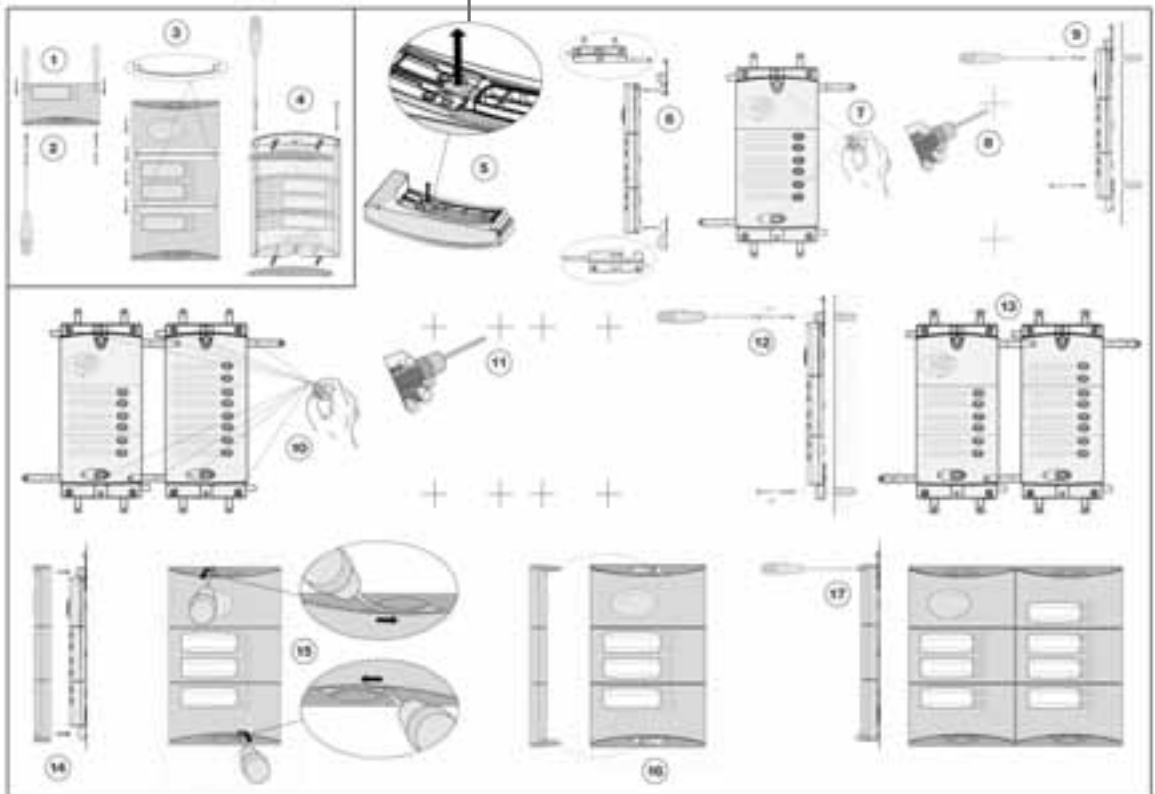

GB

# Installation

**External caller units and rugged metal caller units Refer to the assembly instructions provided with the metal caller unit T-HP. The pilot controller and the radio controllers.**

**1**

Mark the 3 fixing points using the pilot controllers bracket as a template.



**2**

Drill the wall (use a 6mm dia. drill).

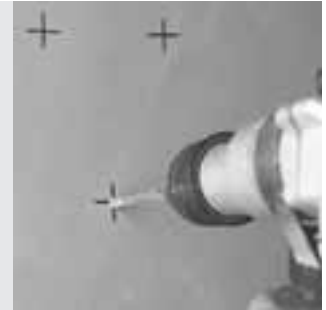

**3**

Screw the bottom of the bracket to the wall (detach and to use one of the 2 small washers). Detach the spare washer so that it doesn't foul the hanging of the controller.



Then screw the top of the bracket.

**4**

Hang the controller on its bracket.



**5**

Fix the controllers base to the bracket using the locking screw.

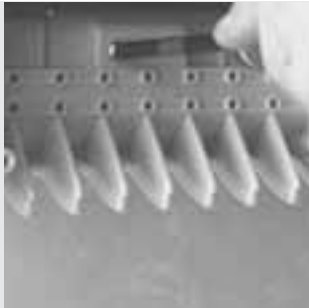

**6**

Detach the cable grommets and pierce them with the aid of a cross head screwdriver in order to allow the passage of the cables. Pass the necessary cables through each cable grommet and cut them to the necessary length.



# Installation

7

Make connections

See following pages

8

Fit the cable grommets (pay attention to the orientation of their installation) to their slots.

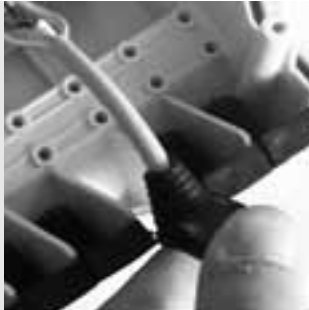

Fit all grommets, even the un-pierced ones to guarantee the weather tightness of the controller.

9

Position and fix the cable clamp (in one piece) with the screws provided.

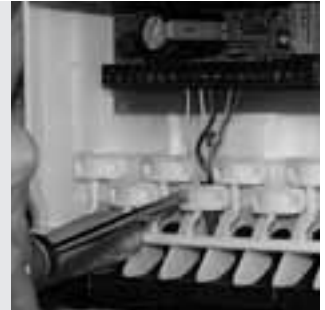

10

Detach the antenna sleeve and slip it over the antenna.



Sleeve



11

Screw the antenna on the base of the radio controller and lower the sleeve of antenna until it fits firmly against the controller.



12

Open out the antenna fully.

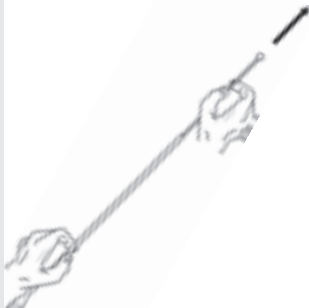

13

Fix the lid to the radio controllers and the pilot controller.



4 captive screws for fixing the lid

GB

# Connections

- ① Make connections.
- ② To close the lids of the controllers.
- ③ Open out the radio controllers telescopic antennas.

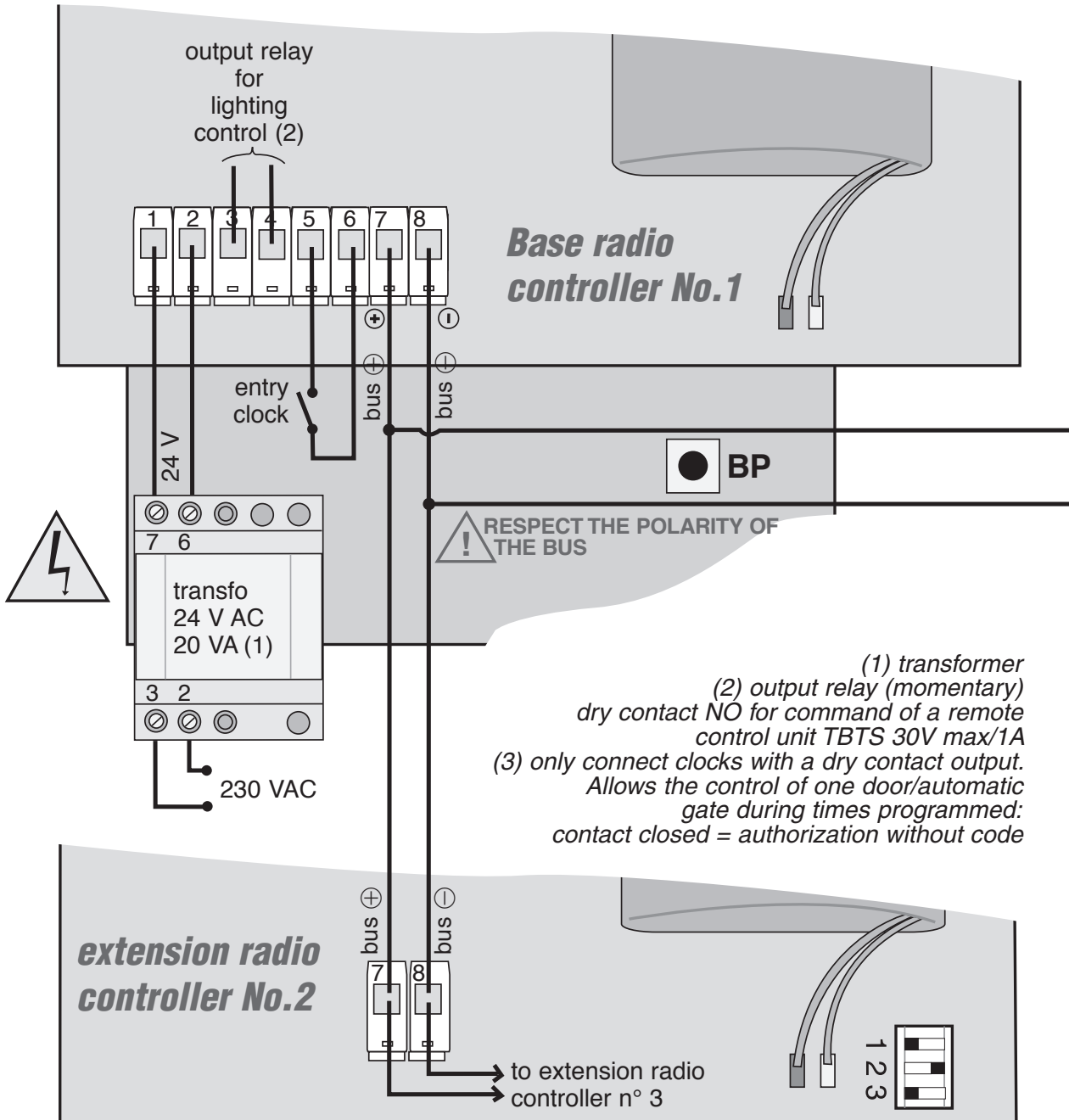

# Connections

## Pilot controller

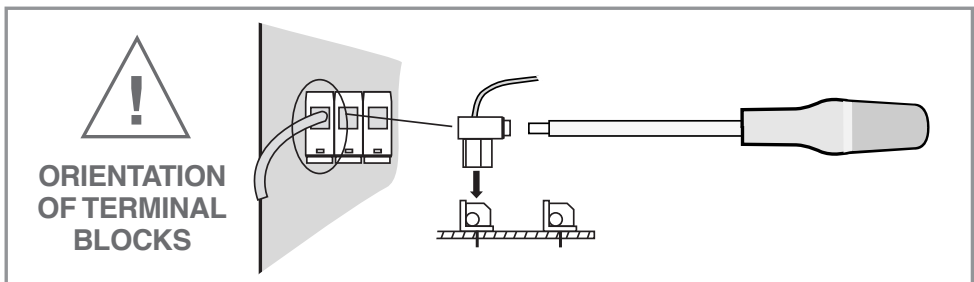
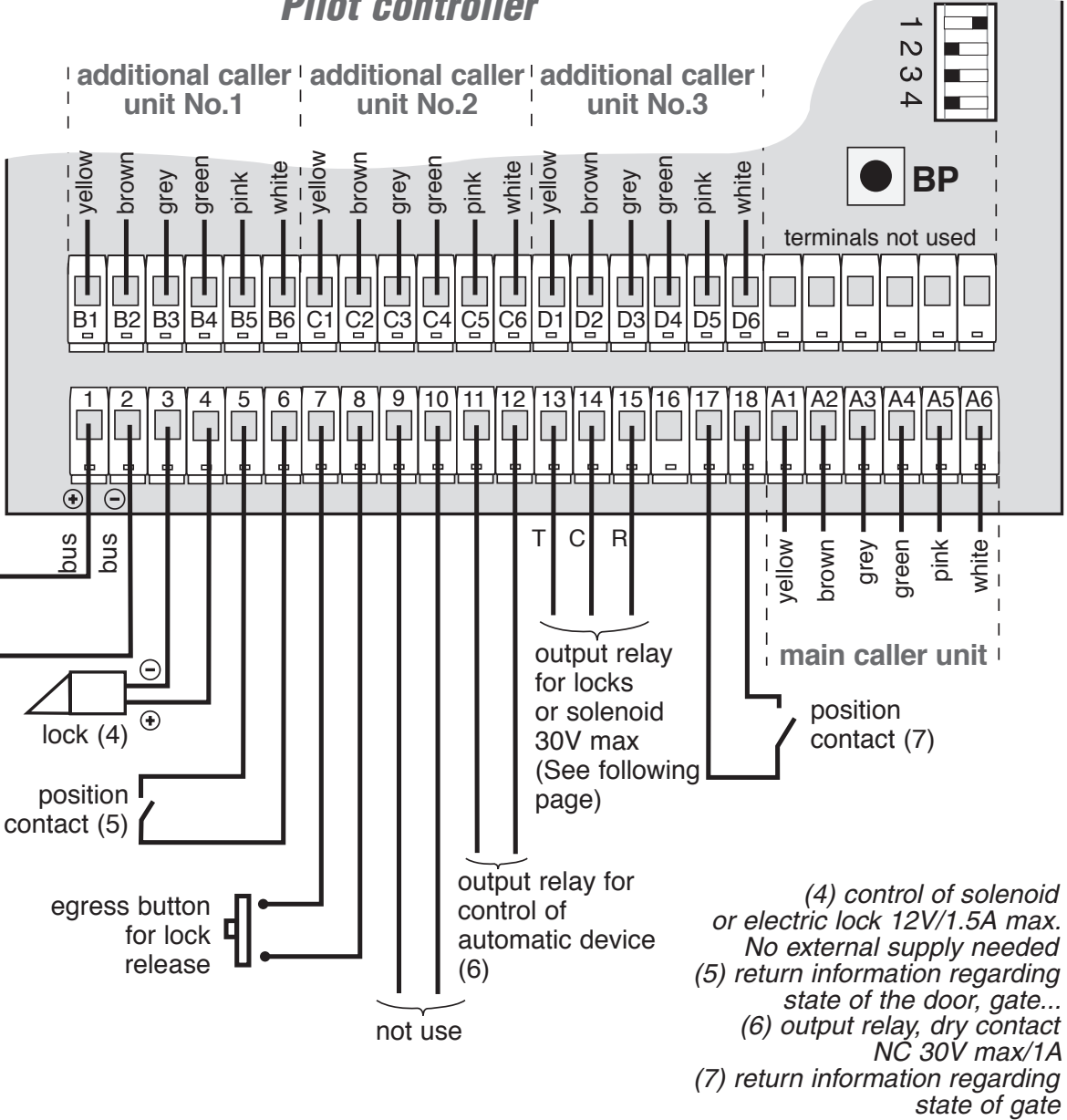

# Connections

## ➤ **Connection of an electric lock with external power of 12V or 24V**

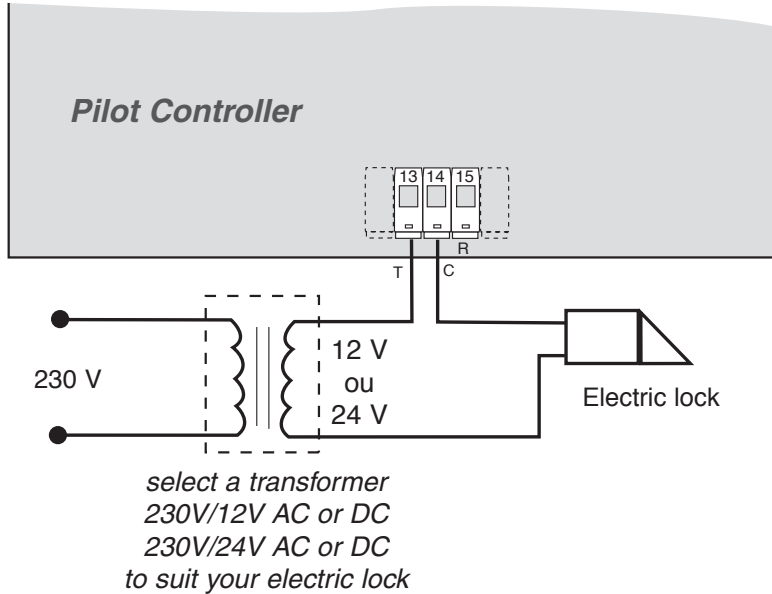

## ➤ **Connection of an electromagnetic solenoid with external power of 12V or 24V**

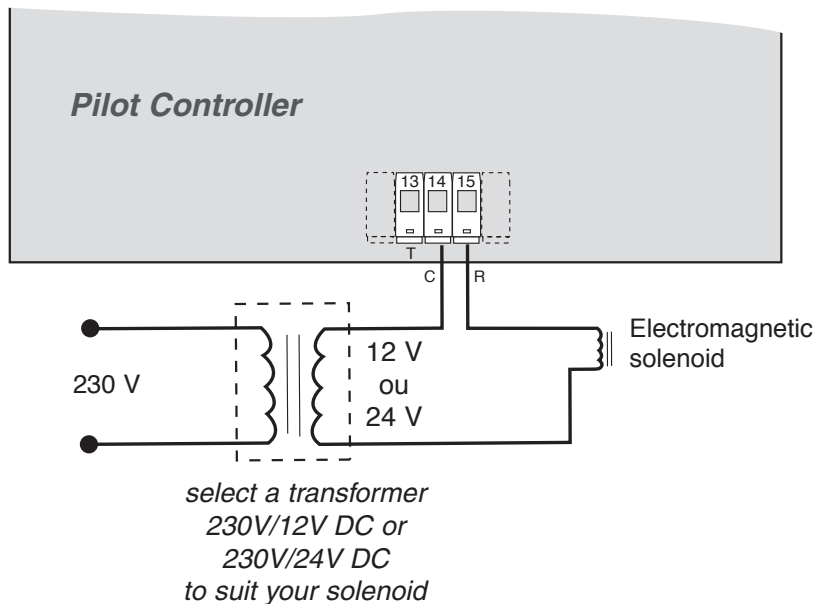

# Connections

## ➤ **Connection of lighting**

Control of existing lighting via a 24 Vac interface relay

**RECOMMENDED RELAY: RTBT Merlin Gerin**

*ref. 15416 or equivalent*

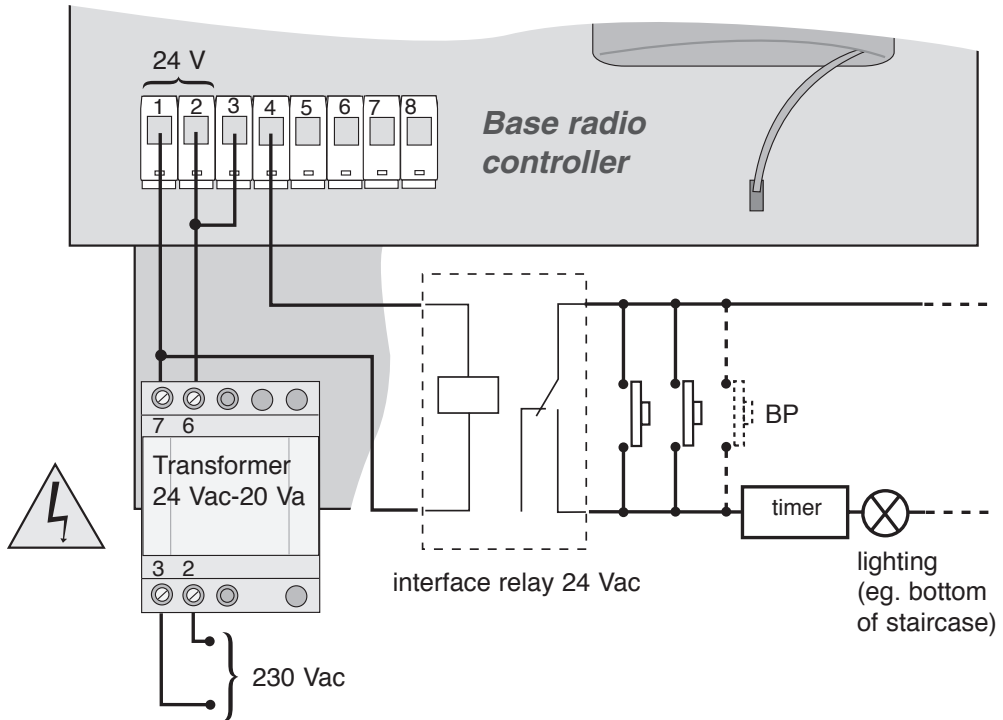

**ATTENTION:** So that the installation can function, it is imperative that the battery systems of each controller are connected and charged for:

- 1 h: minimum charge time for the installation,
- 24 hrs: charge time before use.

# Programming

**ADVICE :** as you progress, label the back of each handset and caller unit with the number of apartment, and/or the name of the resident. Also mark the associated radio controller.

## ➤ **Assigning the handsets to the base radio controller**

**1**

Connect the battery on the pilot controller, as well as on the base radio controller. The charging LED of the pilot controller ignites.

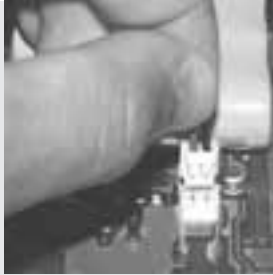

**2**

Set the 4 switches in the pilot controller as indicated.

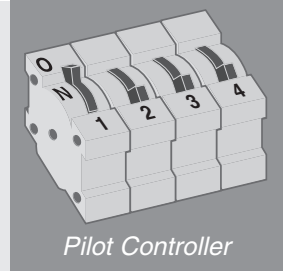

**3**

Briefly press the push button in the pilot controller.

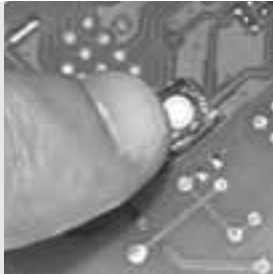



**4**

Briefly press the call button. The caller unit emits audible beeps. You have 10 s to carry out the following stage.



**5**

Simultaneously press and hold the  and  keys until the caller unit emits a long beep.



**6**







The  and  symbols blink and the handset emits a beep.

Repeat steps 4 and 5 for each handset and each call button of the caller unit associated with the base radio controller. Once assignment with the base radio controller is done, make a brief press on the push button  in the pilot controller.

# Programming

## ➤ **Assignment of handsets to extension radio controller(s)**

The extension radio controller is assigned an active number from 2 to 7 by positioning their switches as follows:

Extension radio controller ➡	N° 2	N° 3	N° 4	N° 5	N° 6	N° 7
Position of switches in radio controller						

### Example using extension radio controller n° 2:

**1**

Connect the battery on extension radio controller n° 2. The charging LED of the extension radio controller ignites.

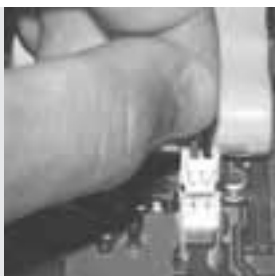

**2**

Position the 3 first switches of the pilot controller as those of radio controller n° 2.

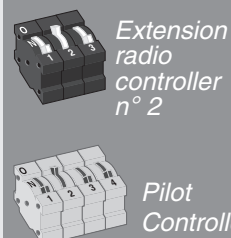

**3**

Briefly press the push button in the pilot controller and in the extension radio controller n° 2.

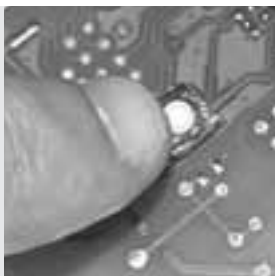

**4**

Repeat steps 4, 5 and 6 of the previous page for each handset and for each call button of the caller unit connected to extension radio controller n° 2.

*Note: any programming carried out on a handset is retained even if the batteries are removed.*

## ➤ **Pass to use mode**

**1**

Once programming is done, position the 4 switches to Off.

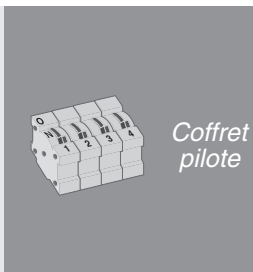

To use the automatic lighting mode, put switch 4° to ON.

**2**

Briefly press the push button in the pilot controller.

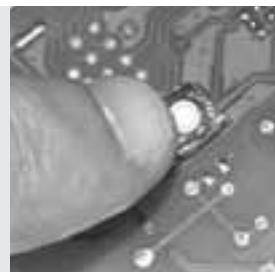

# Programming

## ➤ Programming the main caller unit with keypad

Personal access code	● programming	* 9 9 9 9 * 5	personal access code (4 to 6 numbers)	#	Long bee
	● modification	* [ ] [ ] [ ] [ ] * 5	personal code to modify (4 to 6 numbers)	[ ] [ ] [ ] [ ] #	new personal code (4 to 6 numbers) Long bee
Auxiliary Code	● programming	* [ ] [ ] [ ] [ ] * 1	personal code (4 to 6 numbers)	[ ] [ ] [ ] [ ] #	auxiliary code (4 to 6 numbers) Long bee
	● enable	* [ ] [ ] [ ] [ ] * 6	personal code		Long bee
	● disable	* [ ] [ ] [ ] [ ] * 9	personal code		Long bee
Entry Clock	● enable (1)	* [ ] [ ] [ ] [ ] * 4 1 #	personal code		Long bee
	● disable	* [ ] [ ] [ ] [ ] * 4 0 #	personal code		Long bee

(1) Control of the lock and automatic device can be done by simply pressing the and keys.

## ➤ Restriction of accesses (concerns only the electric lock and or motorized gate only)

Restriction of access while using the auxiliary code	● disable gate access (2)	* [ ] [ ] [ ] [ ] * 7 1 #	personal code		Long beep
	● disable door access (3)	* [ ] [ ] [ ] [ ] * 7 2 #	personal code		Long beep
	● enable both accesses	* [ ] [ ] [ ] [ ] * 7 0 #	personal code		Long beep

(2) With the auxiliary code, the and keys of the caller unit only permit door access.

(3) With the auxiliary code, the and keys of the caller unit only permit gate access.

Restriction of access while using the personal code	● disable gate access (4)	* [ ] [ ] [ ] [ ] * 7 4 #	personal code		Long beep
	● disable door access (5)	* [ ] [ ] [ ] [ ] * 7 5 #	personal code		Long beep
	● enable both accesses	* [ ] [ ] [ ] [ ] * 7 6 #	personal code		Long beep

(4) With the personal code, the and keys of the caller unit only permit door access.

(5) With the personal code, the and keys of the caller unit only permit gate access.

# Programming

**Restriction of access while using the handset**

- disable gate access (6)      \* ( ) ( ) ( ) ( ) ( ) \* 7 9 # Long beep  
personal code
- enable gate access      \* ( ) ( ) ( ) ( ) ( ) \* 7 8 # Long beep  
personal code

(6) The  and  keys on the handset only allow pedestrian access.

## ➤ Specific functioning: professional sites

A press on the call button firstly causes the handset to ring and the caller unit to sound, then the door lock is activated for the opening of the door.

This function is not possible during the hours of access programmed from the clock connected to the base radio controller.

In this case communication is not possible.

**Opening of the main door from the press of the call button**

- programming      \* ( ) ( ) ( ) ( ) ( ) \* 8  # Long beep  
personal code  
call button
- It is possible to do this programming for up to 6 call buttons
- annulation      \* ( ) ( ) ( ) ( ) ( ) \* 8 0 # Long beep  
personal code

**NOTE:** for systems not including of caller unit with keypad, is possible to connect a main caller unit with keypad to the pilot controller at the time of programming.

## ➤ Use of the caller unit with keypad

**Command of door access**

key in: ( ) ( ) ( ) ( ) ( )    
personal code

**NOTE:** door command is possible even if you are not in voice communication (if communication is ongoing, the control of the door ends it).

**Command of gate access**

key in: ( ) ( ) ( ) ( ) ( )    
personal code

**NOTE:** gate command is possible even if you are not in voice communication (if communication is ongoing, the control of the gate ends it).



# Functional test

When working with several handsets they must all be tested.

**1**

Press the call button.  
To confirm the call the caller unit gives out a “DING DONG” at regular intervals for 30 secs.





**2**

The handset sounds (“DING DONG” for 30 seconds if communication with the caller unit is not established) and the  indicator blinks on the display.



**3**

Pick up the handset or press .

The  and  indicators blink alternately to signal that a communication is in progress. Verify the communication with the caller unit.



**4**

To end the communication, press  once again (the handset gives out an audible BEEP to signal the end of communication) or hang up the handset on its base, the  indicator becomes static again.



## ➤ **Adjusting the type and the level of ringing**

**1**

To change of type of ring (3 types of ring tone are available), press and hold the handsets  key for 5 secs.



**2**

To adjust to the desired level of ringing, press the handsets  or  key.















The display indicates the level selected .



NB: it is also possible to adjust the volume level during communication (see User guide).

***The test is finished, you successfully achieved the installation of the DoorPhone!***







# What to do if...?

Question	Answer
<p>What measures should I take before making new connections to the pilot controller (for example, to connect a lock)?</p>	<p>Remove the jumper plug and disconnect the power bus to down-power the pilot controller. Carry out connection of lock and re-establish the supply (*).</p>
<p>What measures should I take before making new connections to the extension radio controller or base radio controller?</p>	<p>Remove the jumper plug and disconnect the power bus to down-power the extension controller. Carry out connections and re-establish the supply (*).</p>
<p>In factory default, the control of door outputs is set to last 2 secs. If this is insufficient how can the time be changed to 5 secs?</p>	<ul style="list-style-type: none"> <li>• Position the first 3 switches in the pilot controller thus: </li> <li>• Briefly press the push button in the pilot controller.</li> <li>• Make a long press (more than 5 secs) on the  key, the handset emits a resonant BEEP and the  indicator blinks.</li> <li>• Press the  key to change to 5 secs, the handset emits 2 resonant Beeps.</li> <li>• To revert back to 2 secs (if necessary), use the same procedure while pressing  instead of .</li> <li>• Then push the  key, so that the pilot controller memorizes the new duration.</li> <li>• Position the first 3 switches of the pilot controller to OFF to return to use mode.</li> </ul>
<p>In factory default, the automatic device trigger is set to last 2.5 secs. If this is undesirable how can the time be changed from between 0.5 secs and 2.5 secs?</p>	<ul style="list-style-type: none"> <li>• Position the first 3 switches in the pilot controller thus: </li> <li>• Briefly press the push button in the pilot controller.</li> <li>• Make a long press (more than 5 secs) on the  key, the handset emits a resonant BEEP and the  indicator blinks.</li> <li>• Press the  key to decrease the duration, the display indicates 0.5 secs increments  (one can either reduce or increase the duration by pressing  ou  ).</li> <li>• Then push the  key, so that the pilot controller memorizes the new duration.</li> <li>• Position the first 3 switches of the pilot controller to OFF to return to use mode.</li> </ul>

(\* ) Press the push button in the pilot controller, after 20 secs each handset, will display the new settings.



# What to do if...?

Question	Answer
After installation, how are additional handset(s) added to the system?	Take stage 2 and 3 of the programming procedure
When one places the handset on its base, it doesn't give out a BEEP and does not display  .	Check the state of batteries of the battery operated base (push the batteries into their holder to ensure the contact between the + pole of each battery and the battery clip) and/or the presence of mains to the mains operated base.
During a communication test the  and  indications do not blink. Communication is not established with the caller unit.	<ul style="list-style-type: none"> <li>• If the  indicator is not displayed, carry out the programming procedure (see Programming chapter).</li> <li>• If the  indicator is displayed it's either:               <ul style="list-style-type: none"> <li>- a radio reception problem,</li> <li>- or a power problem (see previous problem).</li> </ul> </li> </ul>
On the radio handset the  and  indicators blink quickly (if the handset is activated, it also gives out alert BEEPS).	Batteries in the radio controller (partnered with the handset) and/or of the pilots controller are defective, either: <ul style="list-style-type: none"> <li>- a wiring problem with the power supply,</li> <li>- or faulty batteries (see state of the charging LED).</li> </ul>
After communication, the charging LED on the radio controller(s) and or the pilot controller is not lit.	The batteries charge is too low.
The charging LED on the radio controller(s) and/or the pilot controller blinks.	The batteries charge is too high: <ul style="list-style-type: none"> <li>- check the jumpers position (and its contact),</li> <li>- check the batteries contacts.</li> </ul>

# Technical characteristics

## ➤ **Pilot controller**

- Powered by the bus (from the base radio controller)
- Autonomy in case of external power failure: 48 hrs by batteries
- Case: polycarbonate
- Measurements (W x H x D): 155 x 225 x 60mm
- Operating temperature: -20°C to +50°C
- Ingress protection rating: IP 54, protection against dust and harmful deposits and sprays of water from all directions
- Command of electric lock or solenoid: 12V/1,5A max.
- Lock relay outputs:
  - NO dry contact relay output for controlling locks (\*)
  - NC dry contact relay output for controlling a solenoid requiring removal of supply (\*)
  - Dry contact relay output for controlling an automatic device: dry contact 30V/1A max (\*)

## ➤ **Base radio controller**

- Supply: 24VAC - 20 VA Din Rail transformer supplied. Supply protection by fuse (model 5 x 20) 630mA slow blow
- Autonomy in case of external supply failure: 48hrs by batteries **DynaPass**® radio transmissions
- Case: polycarbonate
- Dimensions (W x H x D): 155 x 225 x 60mm
- Operating temperature: -20°C to +50°C
- Ingress protection rating: IP 54, protection against dust and harmful deposits and sprays of water in all directions
- NO output relay for controlling lighting via a TBTS circuit breaker 30V max/1A (\*)
- External entrance clock: only connect clocks with a dry contact (allows programming of times during which command of the lock, solenoid and automatic device can be done without the need of the access code for caller units with keypad).

## ➤ **Extension radio controller**

- Powered by the bus (from the base radio controller)
- Autonomy in case of external power failure: 48hrs by batteries **DynaPass**® radio transmission
- Case: polycarbonate
- Measurements (W x H x D): 155 x 225 x 60mm
- Operating temperature: -20°C to +50°C
- Ingress protection rating: IP 54, protection against dust and harmful deposits and sprays of water in all directions

(\*) For safety connect to a TBTS circuit breaker  
16 V eff max / 22,6 V crête max / 30 VDC max.